

# GATES

SWING  
EXODUS EGRESS  
TRANSPORT CANTILEVER  
PASSPORT ROLL  
ESTATE



DELIVERING STRENGTH,  
DURABILITY AND  
PROVEN FUNCTIONALITY.



FENCE PRODUCTS

[AMERISTARPERIMETER.COM](http://AMERISTARPERIMETER.COM) | 888-333-3422

Experience a safer and more open world

**AMERISTAR®**

**ASSA ABLOY**



# SWING GATES

## Single and Double Swing Gates

All swing gates are manufactured with the highest quality materials by skilled craftsmen and are fully welded for unparalleled strength and durability.



STYLES

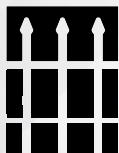

CLASSIC™

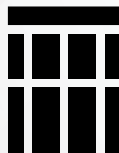

MAJESTIC™

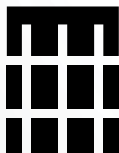

GENESIS™

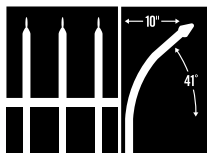

INVINCIBLE™



TRIDENT™



STRONGHOLD™

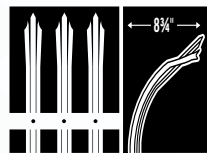

GAUNTLET™

NOTE:  
Styles, colors  
and adornments  
are based upon  
fence system.  
Some options  
not shown.

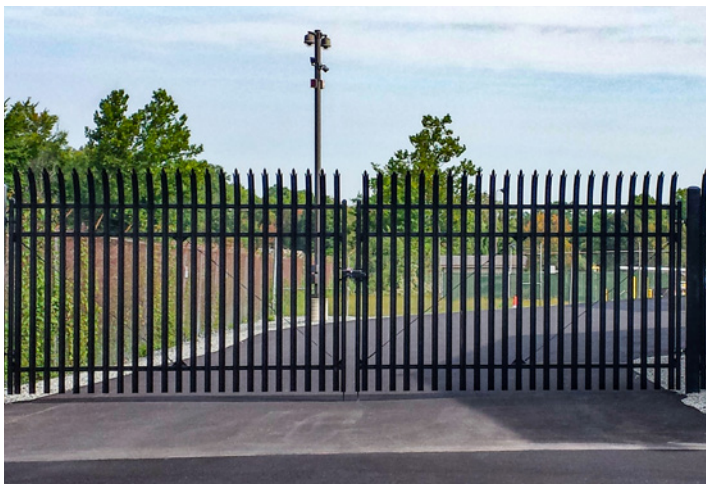

Swing Gates match style and heights of the following fence systems:

- Montage
- Montage Plus
- Montage Commercial
- Montage II
- Aegis Plus
- Aegis II
- Echelon
- Echelon Plus
- Echelon II
- Impasse II
- WireWorks Plus
- WireWorks Anti-Climb

## SWING OPTIONS

- Single
- Double

## PRIMARY APPLICATIONS

- Residential
- Education
- Commercial
- Industrial
- Transportation
- Government
- And More

### COLORS



BLACK



BRONZE



WHITE



SAND

### ADORNMENTS

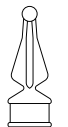

QUAD FLARE



TRIAD



ROYALTY



BUTTERFLY SCROLL



# EXODUS<sup>®</sup> EGRESS GATES

## All-in-One Pedestrian Gate Systems

The Exodus Pedestrian Egress Gate was developed to provide a secure perimeter with a gate solution that functions flawlessly and meets the latest safety standards. This all-in-one gate system includes pre-installed hardware and is available in both Single and Double gate models. The non-removable pins and power transfer components produce a secure gate more capable of restricting vandalism and forced entry.

Designed for full functionality out-of-the-box, the Exodus Egress gate combines frame, gate and hardware into a complete system that is plug and play ready.

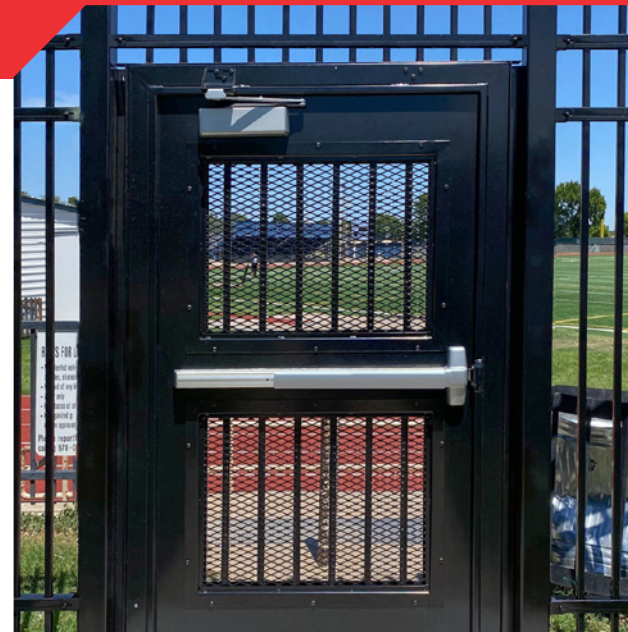

### INFILLS



**PERFORATED METAL**

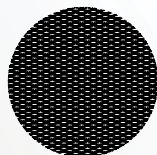

**X-SPAN MODIFIED**

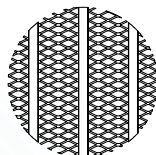

**1" PICKET WITH EXPANDED METAL**

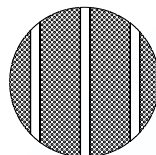

**1" PICKET WITH PERFORATED METAL**

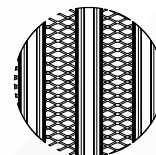

**IMPASSE PALE WITH EXPANDED METAL**  
Anti-Scale available

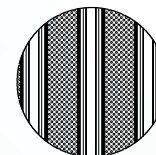

**IMPASSE PALE WITH PERFORATED METAL**  
Anti-Scale available

NOTE:  
Various infills and hardware available. Some options not shown.

## MOUNTING OPTIONS

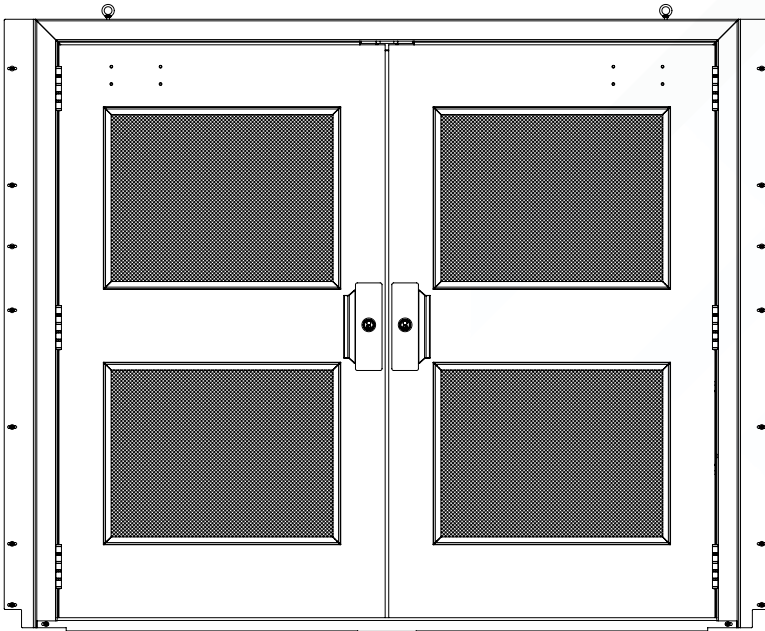

**FLANGE MOUNT**  
Double shown above

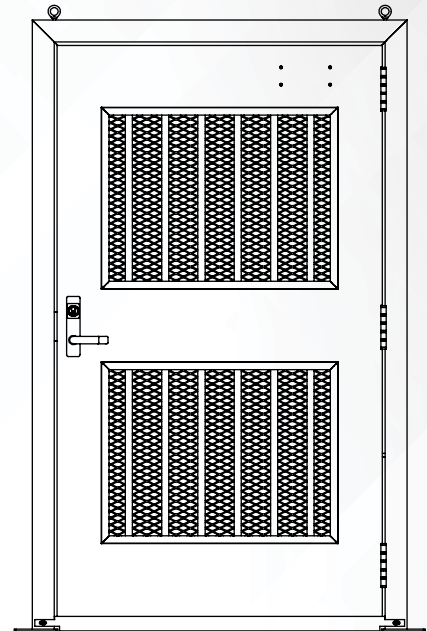

**SURFACE PLATE MOUNT**  
Single shown above

## DESIGN & HARDWARE

Exodus Egress Gates come pre-installed with a specific hardware set. There are various hardware set options available; see product catalog for details. These hardware options include a gate closer, exit device and pull or trim handle set. Exodus Double gates include removable mullion posts and are only available in the flange mounting option.

Hardware set options available to meet California building code.

COLORS

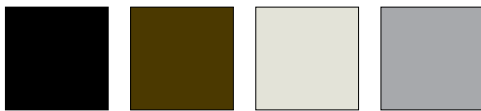

BLACK

BRONZE

SAND

GREY

MOUNTING

Single Mounting Options

**FLANGE  
PLATED  
DIRECT BURY**

Double Mounting Options

**FLANGE**

## EXODUS + AUTOMATIC PEDESTRIAN GATE OPENER

Our newest Exodus configuration raises the standard for egress gates. Specially engineered and integrated with a swing pedestrian gate opener to meet accessibility compliance laws (ADA) and multiple ANSI standards for power operated gates and doors.



# TRANSPORT<sup>®</sup> TRAVERSE GATES

## Engineered Cantilever Gate Systems

TransPort is a revolutionary cantilever gate system made up of three components: frame, facade and hardware.

The component design decreases the risk of damage during transit and does not require a team of installers or machinery to install the gate system. The cantilever gate can easily be installed with a standard three-man crew in about two hours.



STYLES

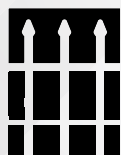

CLASSIC™



MAJESTIC™

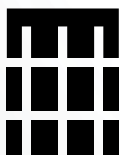

GENESIS™

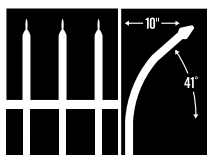

INVINCIBLE™

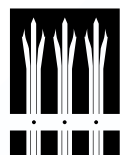

TRIDENT™

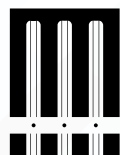

STRONGHOLD™

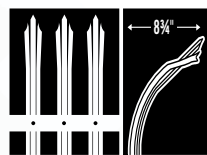

GAUNTLET™

NOTE:  
Styles, colors  
and adornments  
are based upon  
fence system.  
Some options  
not shown.



**TRANSPORT TRAVERSE II®**

1" Ornamental Picket Design

Matches: Montage II | Echelon II | Aegis II



**TRANSPORT TRAVERSE IS®**

2.75" Security Pale Design

Matches: Impasse II



**TRANSPORT ESTATE®**

.75" Decorative Arched Picket Design

Matches: Aluminum Estate Entry Gates

\*Only available in TransPort.

<b>UPRIGHTS</b>	<b>2.5" x 16GA PRE-GALV STEEL</b>
<b>DIAGONAL SUPPORTS</b>	<b>2" x 16GA PRE-GALV STEEL</b>
<b>BOTTOM TRACK</b>	<b>3.75" x 6.5" ALUMINUM PROFILE</b>
<b>TOP TRACK</b>	<b>3" x 5.5" ALUMINUM PROFILE</b>
<b>HEIGHT</b>	<b>4'-10'</b>
<b>OPENINGS</b>	<b>6'-30'</b>

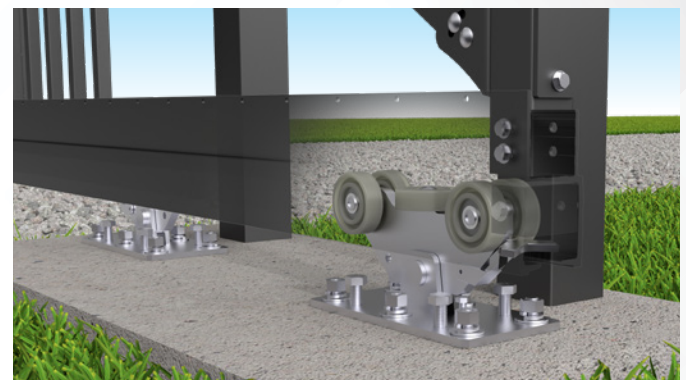

**HARDWARE**

Unlike other engineered cantilever gates, TransPort gates greater than 24' openings come equipped with four internal trollies that distribute the weight of the gate as it is opened and closed.

**TRANSPORT LINK®**

Chain Link Design also available. See [ameristarperimeter.com](http://ameristarperimeter.com) for details.

\*Only available in TransPort.

**PRIMARY APPLICATIONS**

- Water Treatment & Storage
- Municipal Facilities
- Government Facilities
- Airports
- Manufacturing Plants
- Petro & Chemical Facilities
- Power Plants & Substations
- Schools & Universities
- Stadiums & Event Centers

**COLORS**

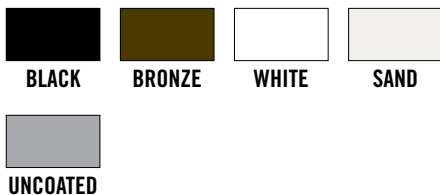

**ADORNMENTS**

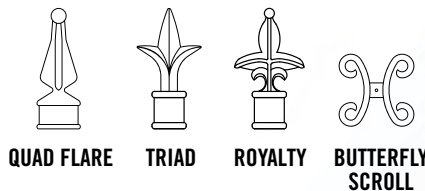



# PASSPORT® GATES

## Steel V-Track Roll Gate Design

PassPort is an innovative roll gate system with a robust fabricated design. Its rigid framework enables the gate system to glide effortlessly across its on-grade track, and its V-Track design provides the least amount of space required for a slide gate system.

The reversible design of the PassPort roll gate insures a flawless installation by allowing the gate to be installed on either side of the gate opening.



STYLES

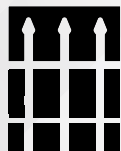

CLASSIC™



MAJESTIC™

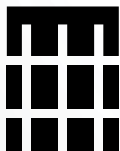

GENESIS™

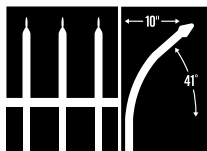

INVINCIBLE™

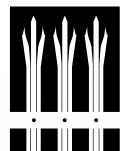

TRIDENT™

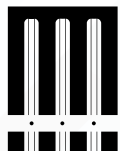

STRONGHOLD™

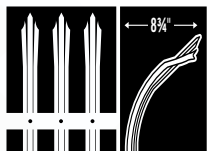

GAUNTLET™

NOTE:  
Styles, colors  
and adornments  
are based upon  
fence system.  
Some options  
not shown.





**PASSPORT COMMERCIAL®**

.75" Ornamental Picket Design

Matches: Montage Plus | Montage Commercial | Aegis Plus



**PASSPORT II®**

1" Ornamental Picket Design

Matches: Montage II | Aegis II

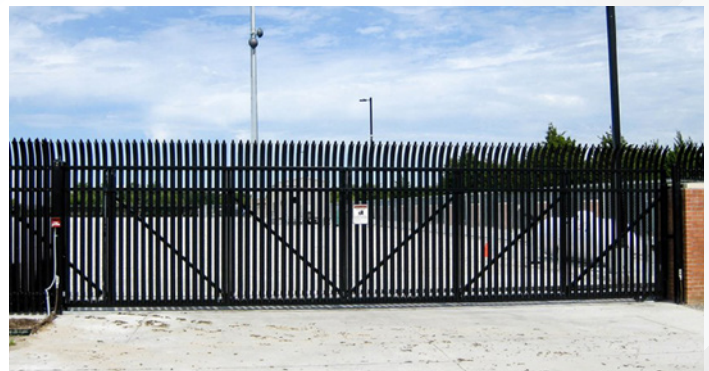

**PASSPORT IS®**

2.75" Security Pale Design

Matches: Impasse II

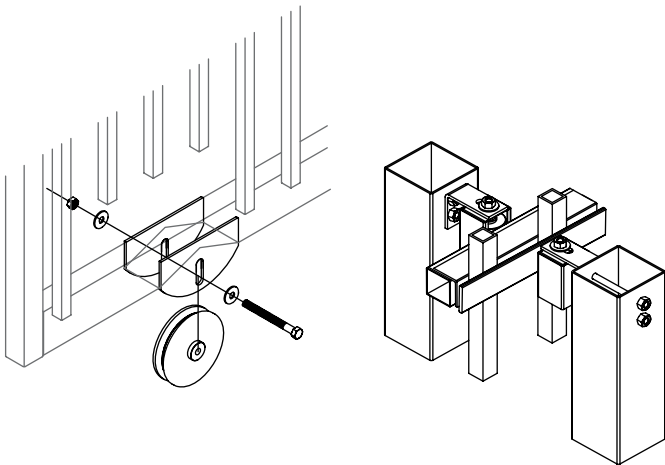

**HARDWARE**

The PassPort roll gate design has been matched with equally superior hardware. The v-track rollers are designed to support more than the recommended load and provide an effortless balance that glides smoothly across its gate opening.

**PRIMARY APPLICATIONS**

- Water Treatment & Storage
- Municipal Facilities
- Government Facilities
- Airports
- Manufacturing Plants
- Petro & Chemical Facilities
- Power Plants & Substations
- Schools & Universities
- Stadiums & Event Centers

**COLORS**

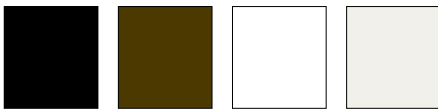

BLACK

BRONZE

WHITE

SAND

**ADORNMENTS**

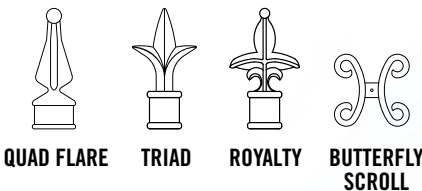

QUAD FLARE

TRIAD

ROYALTY

BUTTERFLY SCROLL



# ESTATE<sup>®</sup> GATES

## Steel and Aluminum Entry Gates

The Estate entry gate design is a statement in itself. It adds value and aesthetics to complete the elegant look of a wrought iron gate.

Available in both Single and Double Swing. Private businesses, large estates and condominium complexes are ideal properties for the prestigious appeal of the Estate entry and driveway gate.



STYLES

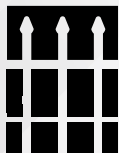

CLASSIC™



MAJESTIC™

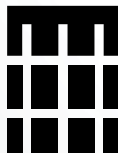

GENESIS™



WARRIOR™\*

\*Only available for Aluminum Estate

COLORS



BLACK



BRONZE



WHITE\*



SAND



**STEEL ESTATE**

3-rail or 4-rail options  
 1" and 3/4" picket options  
 4', 4 1/2', 5', 6' or 7' heights

**SINGLE SWING**

8', 10', 12' and 14'\* nominal openings

**DOUBLE SWING**

16', 18', 20', 22', 24', 26'\* and 28'\* nominal openings

\*Openings available in Montage II only

**Matches: Montage II | Montage Commercial | Montage Plus**

Steel Estate Entry Gates are designed with a timeless elegance and are built to last with welded construction at every intersection. The one-of-a-kind compound arch provides a seamless transition from ornamental fence to decorative gate.



**ALUMINUM ESTATE**

5-rail  
 1" and 3/4" picket options  
 4', 5', 6', 7' or 8' heights

**SINGLE SWING**

8', 10', 12' and 14' nominal openings

**DOUBLE SWING**

8', 10', 12', 14', 16', 18', 20', 22', 24', 26' and 28' nominal openings

Aluminum Estate Entry Gate design adds value and aesthetics to complete an elegant old world look of wrought iron. This unique design is fabricated from heavy aluminum profiles for years of durable worry-free operation.

**ADORNMENTS**

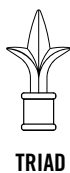
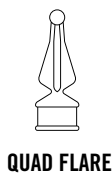

NOTE:  
 Rings available for Aluminum Estate Entry Gates. Block and Old English Lettering available.

\*\*Adornments fit 3/4" picket Estate Entry Gates

**PRIMARY APPLICATIONS**

- Ranch Estate
- Stadiums & Arenas
- Apartments
- Assisted Living
- Public Housing
- Parks and Recreation
- Self Storage

# Why Choose Ameristar?

## KNOWLEDGE AND EXPERIENCE

For over 30 years we've delivered aesthetically pleasing, high-quality and innovative fencing products with superior design strength and easy installation.

## PROVEN CAPABILITIES

Our integrated in-house processes, extensive raw materials and finished goods inventory translate into quality, on-time delivery.

## INDUSTRY LEADERSHIP

We continually raise the bar in manufacturing customer-focused solutions. Our high standards produce premium products that go beyond merely meeting minimum industry standards.



Scan to learn  
more about  
our gates.



[AMERISTARPERIMETER.COM](https://www.ameristarperimeter.com) | 888-333-3422

Experience a safer and more open world

#6004 | 04/2024

**AMERISTAR®**  
**ASSA ABLOY**